

SEAM CLAMPS PRO

PRODUCT SHEET

Large selection of mounting solutions

Direct mounting on any available seam roof

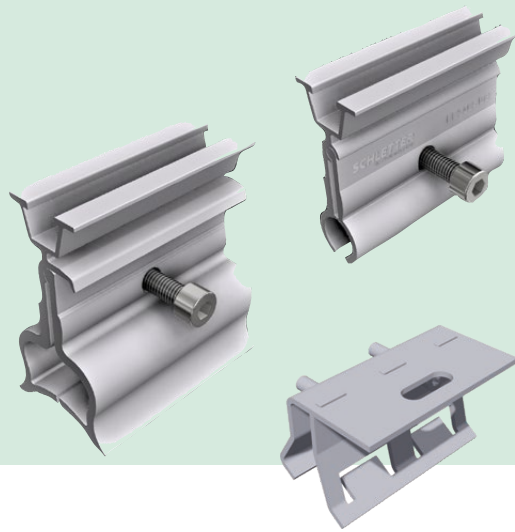

FOR ALMOST ANY TYPE OF SEAM ROOF

Schletter seam clamps offer perfect mounting solutions for almost any type of seam roof. (Alternatively, our FixPlan system also enables direct mounting into the substructure - see FixPlan product sheet).

NOTE

In case of titanium zinc sheet metal, the load-bearing capacity of the seams must be observed.







Compatibility must also be checked on site.

TECHNICAL SPECIFICATIONS

Scope of application	Sheet metal seam roofs with load-bearing sheet metal seams
Material	Clamps: Aluminium Clamps 112001-000 and 112007-000: Stainless steel 1.4301 Screws: Stainless steel
Planning aid	Configuration and structural analysis via Schletter Configurator
Structural analysis	Structural analysis based on recognized engineering standards. Verification of structural safety of the mounting system is based on Eurocodes and general construction approvals. The load assumptions comply with DIN EN 1991-1 and the regulations of the national annex. Roofing and building certificates are not included. Any instructions on required certification and approval must be observed.
Warranty	25 years on structural components, according to our warranty terms
Supplementary documents	Assembly instructions Seam Clamps PRO Component overview - Special fastening solutions

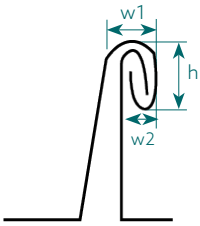

SEAM CLAMPS PRO

ARTICLE OVERVIEW

112001-000	Seam clamp 503 VA for standing seam roof	PU:50	
112001-105	Seam clamp Pro 503 for standing seam roof	PU:50	
112001-110	<p>Seam clamp Pro 504 for standing seam roof <i>Suitable in particular for double standing seam roofs made of titanium zinc sheet metal</i></p>	PU:50	  <p>Possible seam dimensions (observe dimensional drawing): $h = 11 - 13 \text{ mm}$ $w1 = 4 - 6 \text{ mm}$ $w2 = \text{max. } 3 \text{ mm}$</p>
112002-103	Seam clamp Pro 510 for Kalzip ^{®*} , Bemo ^{®*}	PU:50	
112003-103	Seam clamp Pro 520 for Zambelli RIB-ROOF 465* et al.	PU:50	
112004-102	Seam clamp Pro 522 for Zambelli RIB-ROOF 500* et al.	PU:50	
112006-102	Seam clamp Pro 524 for FischerKLIPTEC* 52/400 et al.	PU: 50	

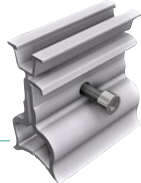

SEAM CLAMPS PRO

ARTICLE OVERVIEW

112007-000	Seam clamp 525 VA for Domico Domitec®** et al.	PU: 50	
112012-107	Seam clamp Pro 551 for KlipLok 700/406 <i>For KlipLok 700 HiStrength, Classic 700, 406 et al.</i>	PU: 100	
112023-112	Seam clamp Pro 562 Universal	PU: 50	

*All trademarks mentioned herein are the property of their respective owners.

ACCESSORIES (to be ordered separately)

129063-002	RapidCon90	PU: 100	
or			
129063-020**	Rapid cross-connector 90 Pro <i>Fully pre-assembled for ProLine channel For cross rail system of the Proline series</i>	PU: 150	

** available until end of Q2/2023